

### FCR PRIMA T2 Specifications

Standard Components	FCR PRIMA T2 Image Reader (Model: CR-IR 392)
Applicable Console	FCR PRIMA Console, FCRView, CR Console, Console Advance
Main Connectable Imagers	DRYPIX PRIMA/ Smart/Lite/Plus/4000
Supplies	Imaging Plate ST-VI: 35 × 43 cm (14" × 17"), 35 × 35 cm (14" × 14"), 10" × 12", 8" × 10", 24 × 30 cm, 18 × 24 cm, 15 × 30 cm IP Cassette Type CC: 35 × 43 cm (14" × 17"), 35 × 35 cm (14" × 14"), 10" × 12", 8" × 10", 24 × 30 cm, 18 × 24 cm, 15 × 30 cm
Time Required for IP Feed/Load	Min. 49 sec.
Processing Capacity	Up to 73 IPs/hr.
Reading Specification	10 pixels/mm, 5 pixels/mm
Time to Start on Display	Min. 33 sec.
Time to Print on DRYPIX PRIMA	Approx. 165 sec. (Approx. 155 sec.)* in case of 35 × 43 cm (14" × 17")
Number of Stacker	1
Network	10 Base T/100 Base TX
Dimensions (W × D × H)	560 × 540 × 392 mm (22" × 21" × 15")
Weight	39 kg (86 lbs.)
Power Supply Conditions	Single phase 50-60Hz AC120-240V ±10% 1.9A (max)
Environmental Conditions	Operating Conditions: • Temperature: 15-30°C • Humidity: 15-80%RH (No dew condensation) • Atmospheric pressure: 750-1060 hPa

This equipment is a Class 1 laser product (IEC60825-1:2001).

\*In the high speed mode

# FCR PRIMA T2

Extremely fast processing in a compact body streamlines diagnosis

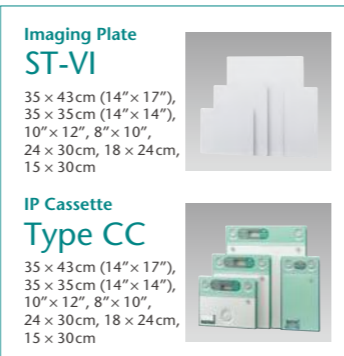
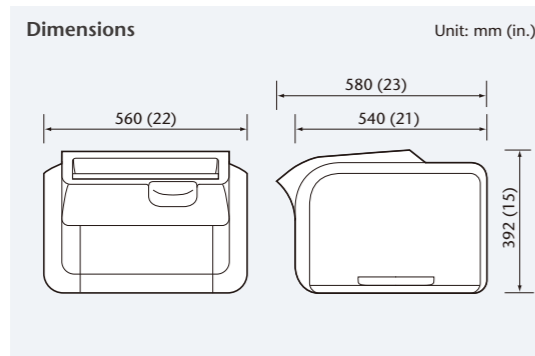

This compact table-top reader unit has outstandingly high-speed processing capability to challenge the common misconception of CR



Weight  
**39 kg**

392 mm

540 mm

560 mm

Processing Capacity  
**73** IPs/hr.

• The above value is for IPs of 18 x 24 cm.



All-in-one workstation



**FCR PRIMA Console / FCRView**

FCR PRIMA Console and FCRView are all-in-one workstation which meet various radiographic imaging needs. The features include image acquiring, processing, viewing and archiving.

\*FCR PRIMA T2 can also be used with the CR Console and Console Advance.

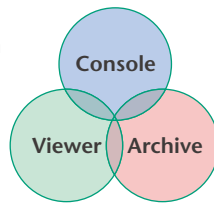

## High-Speed Processing

FCR PRIMA T2 is a table-top reader unit which boasts a world-class high processing speed of 73 IPs/hour. In the high speed mode (5 pixels/mm), throughput is enhanced almost 70% compared with FCR PRIMA T (only for IPs of 14" x 17" and 14" x 14"). As with all Fujifilm equipment FCR PRIMA T2 is easy to operate. It will help reduce patient waiting time and greatly increase the efficiency of examination workflow.

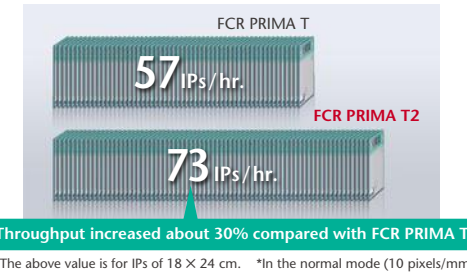

## Space-Saving Design

FCR PRIMA T2, with its light and compact table top design, can be placed on a desk, shelf or anywhere space is limited. As this is a fully digital reader, neither a darkroom nor automatic processor is required. FCR PRIMA T2 can always be installed in the space formally used by a chemistry based processor.



## Stable High-Quality Images

Although this is a compact machine its excellent image quality is the same as that produced by the rest of the FCR range. Image Intelligence™, Fujifilm's proprietary image processing technology, enhances image contrast and sharpness, without any deterioration of details. FCR PRIMA T2 supports accurate diagnosis by offering stable and optimized image quality.



### MFP\* Multi-Frequency Processing

Enhances FCR images. All diagnostic scopes will be enhanced except for noise. \*Optional software



### FNC Flexible Noise Control

Provides a non-grainy image by mainly isolating and suppressing the noise for the signal.

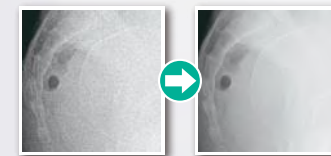

### GPR Grid Pattern Removal

Removes the stationary grid patterns thus preventing Moiré from being generated resulting in easier diagnosis.

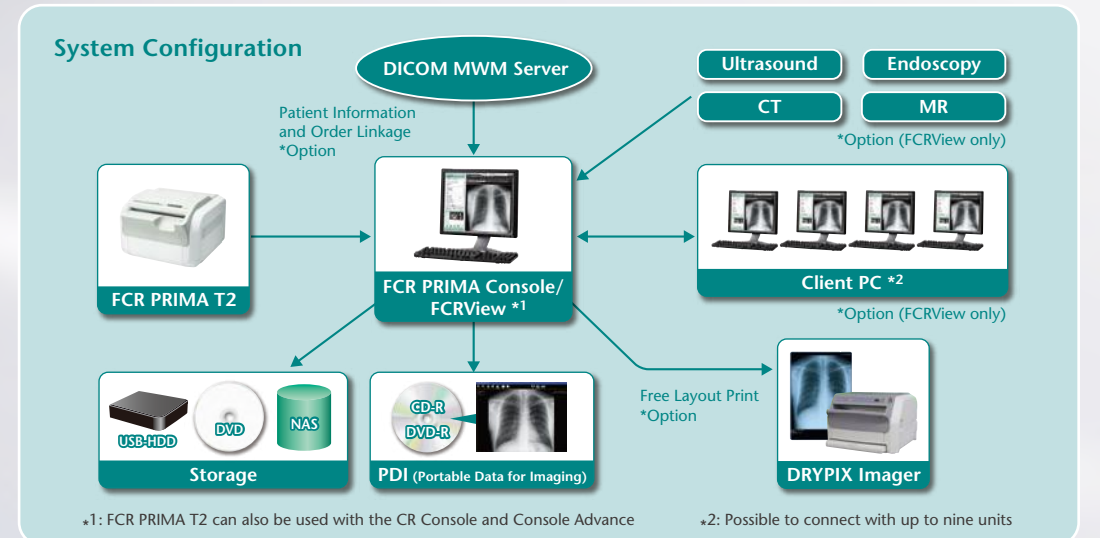
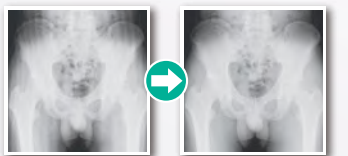

\*1: FCR PRIMA T2 can also be used with the CR Console and Console Advance

\*2: Possible to connect with up to nine units